

RAYPAK VERMONT LHEC30 GAS LOG FIREPLACE INSERT



Installation and Operating Instructions

For models LHEC30RFNAU (Nat Gas) and
LHEC30RFPAU (Propane)

CONTENTS

Part 1: For Your Safety

Part 2: Installation Instructions

- Important Curing/Burning Instructions
- Locating The Fireplace Insert
- Fireplace and Trim Dimensions
- Mantels
- Framing and Finishing
- Zero Clearance Applications
- Gas Supply/Pipe Sizing
- Gas Manifold Pressures
- Preparing Appliance for Installation
- Fan Kit
- Fan Removal Instructions
- Installation of Trim Switch for RN/RP Gas Valve
- Fireplace Installation
- Flue Installation
- Chimney Liner Installation
- Draft Relief Opening
- Test Chimney Draw
- Flue Safety System
- Flue Safety Switch Access
- Ceramic Refractory Installation
- Wiring Diagram

Part 3: Operating Instructions

- General Glass Information
- Louvre Removal
- Glass Cleaning

- Glass Frame Removal
- Log and Burner Lava Rock Installation
- Large Lava Rock Placement
- Flame Adjustment
- Flame Characteristics
- First Firing
- Lighting and Operating Instructions
- Troubleshooting – Gas Control
- Instructions for RF Comfort Control Valve

Part 4: Warranty

Part 1: For Your Safety

For your safety do not operate this appliance before reading this instruction book.

Warning: Improper installation, adjustment, alteration, service or maintenance can cause injury or property damage. For assistance or additional information consult with Raypak Australia, your Raypak distributor, qualified installer or accredited Rheem Australia Service Agency.

WHAT TO DO IF YOU SMELL GAS?

DO NOT try to light any gas appliance.

DO NOT touch any electrical switch.

Turn off gas supply at the meter.

Immediately call Rheem service or your gas supplier or licensed gasfitter.

Note: Some gases are heavier than air and it maybe necessary to check for gas leaks at floor level.

CAUTION!

DO NOT operate this appliance before reading this instruction booklet.

DO NOT place articles or objects on or against the appliance.

DO NOT store chemicals or flammable materials in the same room as this appliance.

DO NOT store chemicals or flammable materials on, or spray aerosols near this appliance.

DO NOT operate with panels, covers or guards removed from the appliance.

FOR SAFE INSTALLATION AND OPERATION OF YOUR GAS FIREPLACE PLEASE NOTE THE FOLLOWING:

- a) This appliance gives off high temperatures and should be located out of high traffic areas and away from furniture and drapes/curtains.

- b) Children and adults should be alerted to the hazards of high surface temperatures of this appliance and should stay away to avoid burns or ignition of clothing.
- c) Children should be carefully supervised when they are in the same room as the appliance.
- d) Under no circumstances should this appliance be modified. Parts removed for servicing should be replaced prior to operating this appliance again.
- e) Installation and any repairs to this appliance must be carried out by a suitably qualified and licensed service person. A professional service person should be contacted to inspect this appliance annually. Make it a practice to have your gas appliances serviced annually. More frequent cleaning may be required due to excess lint and dust from carpet, bedding material etc.
- f) Control compartments, burners and air passages in this appliance should be kept clear of dust and lint. Make sure that the gas valve and pilot light are turned off before you attempt to clean this unit.
- g) The appliance flue or chimney should be checked at least once a year and cleaned if required.
- h) Keep the area around your appliance clear of combustible materials, gasoline and other flammable vapour and liquids. This appliance should not be used as a drying rack for clothing etc.
- i) Under no circumstances should any solid fuels (wood, coal, paper, cardboard etc. be used in this appliance.
- j) When the zero clearance kit is installed directly on carpet, vinyl tiles, linoleum or any other combustible material other than wood, this heater must be installed on a metal or wood base extending the full width and depth of the heater. This insert cannot be installed directly onto or into combustible materials.

Part 2: Installation Instructions

- **Important Curing/Burning Instructions**

Please read the following instructions carefully

It is normal for fireplace inserts fabricated of steel to give off some expansion and /or contraction noises during the start up and cool down cycles.

It is not unusual for your Raypak LHEC30 Fireplace Insert to give off some odour the first time it is lit. This is due to the curing of the paint and any undetected oil from the manufacturing process.

Please ensure that you room is well ventilated and that all windows are opened prior to lighting the appliance for the first time.

It is recommended that you burn your Raypak LHEC30 Fireplace Insert for at least 10 hours with the fan in the OFF position the first time you use it.

Locating Your LHEC30 Fireplace Insert with Zero Clearance Kit



Fig. 1 Locating unit with zero clearance kit.

- | | |
|-------------------------|-----------------------|
| A) Flat on wall | B) Cross corner |
| C) Island | D) *Room divider |
| E) *Flat on wall corner | F) Chase installation |

Note: (Fig. 1) When you install you Raypak Fireplace Insert in (D) Room divider, (E) Flat on wall corner positions or (F) Chase installation a minimum of 153mm clearance must be maintained from the vertical wall to the outer edge of the trim.

- **Fireplace Insert Installations**

Before installing the gas fireplace insert in a working fireplace, consideration must be given to the functioning needs of the fireplace. The minimum fireplace opening dimensions required for successful installation of this appliance is width 731mm x height 534mm x depth 394mm. The design of the chimney for effective venting must be determined. The availability of the gas supply as well as electricity must be confirmed prior to the installation of this appliance.

This appliance is designed to be installed with a minimum vertical flue height of 3.7m and a maximum vertical flue height of 10.7m.

- Fireplace and Trim Dimensions

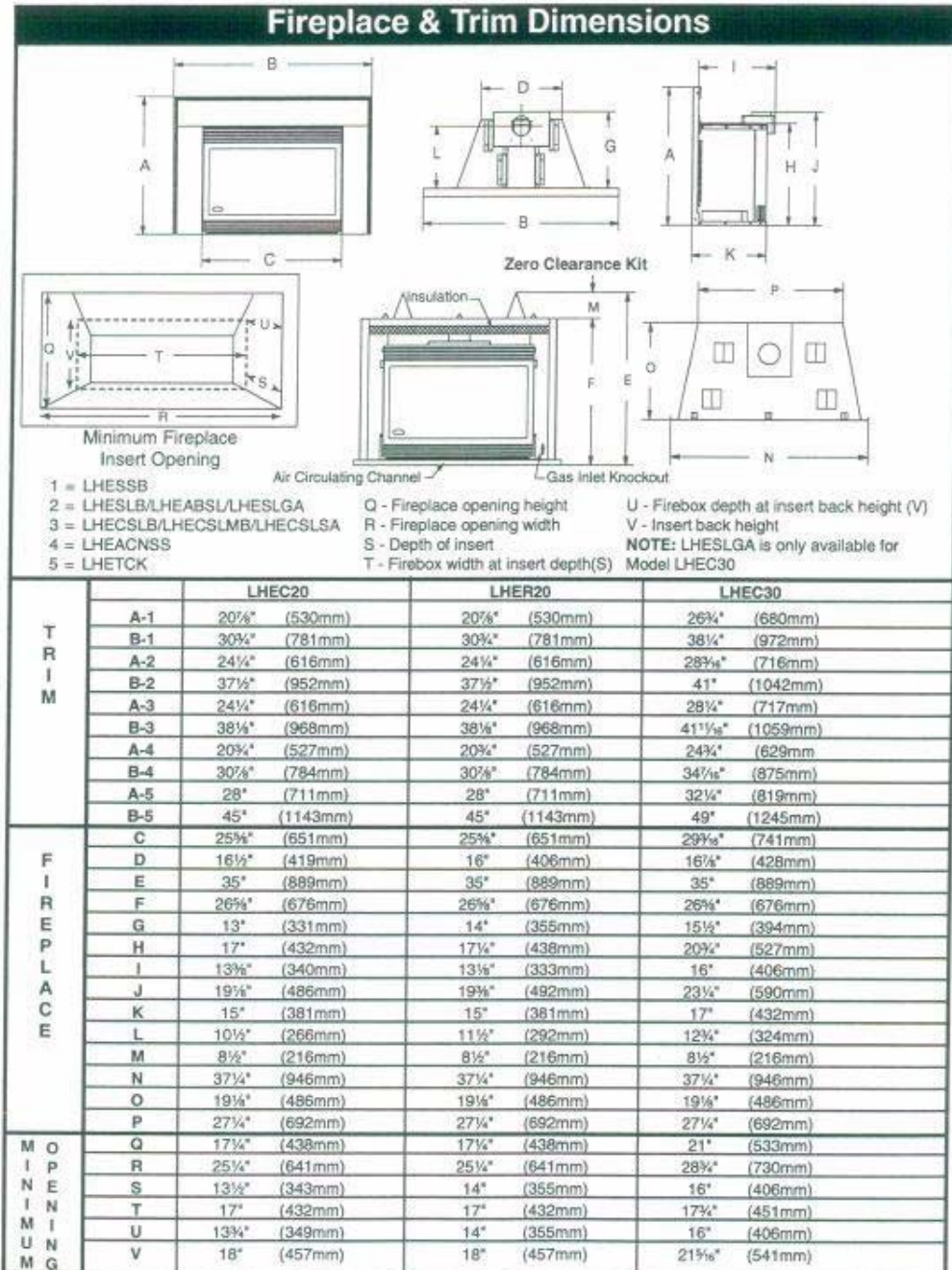

- **Mantels**

When the appliance is installed into a wood burning fireplace, the minimum distance the mantel can be placed above the fireplace is governed by AS5601.

For applications requiring the use of a Zero Clearance Kit, the minimum height a mantel can be installed above the fireplace is 610mm from the top of the upper louvres. The maximum mantel depth is 200mm.

The underside of the mantel will become warm. Only use finishes that are heat resistant and do not discolour.

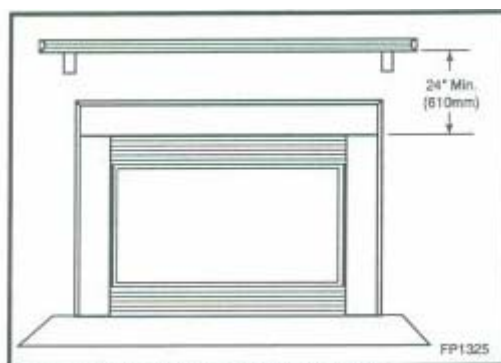

Fig. 2 Minimum mantel height above fireplace.

- **Framing and Finishing**

For zero clearance applications, it is important to determine the finished facing material before beginning to frame. This will allow for the thickness of the finishing material between the frame and the fireplace trim.

Consideration must also be given to the 25mm depth of the air inlet channel sitting on the fireplace base. Finishing material for the hearth should be flush with the top of the air inlet channel.

If the fireplace is installed at floor level a non-combustible hearth must extend a minimum of 305mm in front of the fireplace.

If the fireplace is recessed into the wall and at least 305mm above floor level, no hearth is required.

The use of wall paper adjacent to this fireplace is not recommended as high temperatures given off by this appliance may adversely affect the binders in the adhesive used to apply the wallpaper.

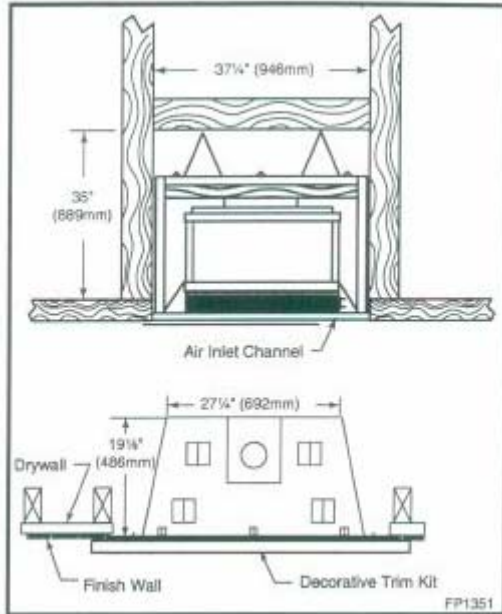

Fig. 3 LHE insert framing dimensions.

NOTE: Insulating around the fireplace will result in over heating and possible malfunctioning of the circulating fan.

- **Zero Clearance Applications**

Ensure that the room is adequately ventilated when this component is installed.

For installations other than in existing wood burning fireplaces such as new construction or renovation projects, a Zero Clearance Kit must be installed. The kit enables these inserts to be installed in combustible environments. Whenever using a Zero Clearance Kit consideration must be given to the dimensions of the Zero Clearance Kit and the requirements of the Flue Kit.

Note: If a Zero Clearance Kit is required for the LHEC30 model only the Raypak zero clearance kit HEZC must be used.

- **Gas Specifications**

Gas Specifications				
Model	Gas Type	Gas Control	Max. Input Mj/h	Min. Input Mj/h
LHEC30RFN	Natural Gas	Comfort Control	32Mj/h	22.2Mj/h
LHEC30RFP	Propane	Comfort Control	32Mj/h	23.7Mj/h

Gas Inlet and Manifold Pressures		
	Nat Gas	Propane
Minimum Inlet Pressure	1.1 kPa	2.75 kPa
Maximum Inlet Pressure	3.50 kPa	3.50 kPa
Manifold Pressure	0.87 kPa	2.50 kPa

- **Gas Type Conversion**

Contact Rheem Spare parts in your State for gas type conversion kit and instructions.

- **Preparation for Installation**

Before installation, remove glass door and logs from unit and check to make sure there is no hidden damage to the unit.

- **Gas Fitting Line Installation**

Warning: When purging the gas fitting line, the front glass must be removed.

If gas fitting line has been previously completed, check that the gas fitting line is of adequate size. Refer to Australian Standard AS5601 Gas Installations.

The gas fitting line can be installed through the rear or the base of the heater.

NOTE: When making the gas connection to the appliance inlet fitting, hold the 10mm 3/8" BSP fitting with a spanner when tightening the gas inlet pipe compression nut.

For Propane installations an approved gas regulator must be fitted in accordance with AS5601.

Ensure copper tube meets the requirements of Australian Standard AS1432 Type B.

- **Venting Installation**

1. This fireplace insert may be installed in and vented through any solid fuel fireplace that has a minimum opening of 730mm x 535mm x 395mm and has been constructed and installed in accordance with state or local building codes and is constructed of non-combustible materials.
2. In order to gain minimum gas insert fireplace opening requirement, if the fire brick refractory is removed from a factory built fireplace, a minimum of 6mm air space is required between the gas insert fireplace's outer casing and the inner wall of the factory built fireplace.
3. In order to gain the best performance, safety and efficiency for the LHEC30 Fireplace insert, the appliance must be installed with the approved 100mm

(4") diameter chimney liner. The Raypak chimney liner kit must be installed in accordance with AS5601.

4. Any flue damper or blockage must be removed from the chimney prior to installation of the insert.
5. The chimney must be clean and in good working order and constructed of non-combustible materials.
6. Make sure that all chimney cleanouts fit properly so that air cannot leak into the chimney.
7. Install the appliance without the trim frame and make all gas fittings and electrical connections.
8. Install the decorative trim frame. Please refer to the frame assembly instructions.

Warning: Installer must attach red warning plate with screws supplied with the gas fireplace insert to the inside of the firebox of the fireplace into which the gas fireplace insert is installed.

Warning: Cutting any sheet metal parts of the fireplace, in which the gas fireplace insert is to be installed, is prohibited.

Warning: If the factory-built fireplace has no gas pipe access hole(s) provided, an access hole of 40mm or less may be drilled through the lower sides of bottom of the firebox. This access hole must be plugged with a non-combustible insulation after the gas fitting line has been installed.

Warning: Some factory-built fireplaces have air passages on the face of the fireplace for zero clearance capabilities. Under no circumstances should these passages be blocked.

Zero clearance kit minimum clearance to combustible materials is 25mm (1") for twin skin flue. The use of single skin flue is not permitted for this type of installation.

As with any natural draught appliance the end of the flue must be at least 500mm above the nearest part of the roof. Refer to AS5601 for details.

Warning: A minimum of 3.7m vent height is required to effectively vent this appliance.

Common Flue Installation: In some installations it is possible to vent more than one appliance into the same flue. You must ensure that the shared flue has the proper capacity to adequately discharge the flue gases for the appliances using the shared flue. Refer to AS5601.

- **Chimney Liner Installation**

Insert liner from top of chimney through the damper opening and attach to the 100mm (4") flue collar. For best results use three (3) sheet metal screws and a hose clamp.

By packing non-combustible fibreglass insulation around the liner in the damper area will isolate the fireplace cavity from the chimney and prevent draughts and noises during operation.

In the case that the fireplace opening is only minimum height (533mm) and access from the front is not possible, remove the flue collar plate – unscrew and slide out from the back of the appliance. Now attach the liner to the flue collar, lift up and slide the flue collar plate back onto the top of the unit. It is important that the plate is completely inserted and the front screw is fastened again in order to line up the flue outlet and the liner correctly. (Ref Fig. 11)

Warning: If the fireplace lintel is wider than 205mm (8”), the height of the fireplace opening must be 635mm (25”) to allow for a 90° offset elbow to be installed.

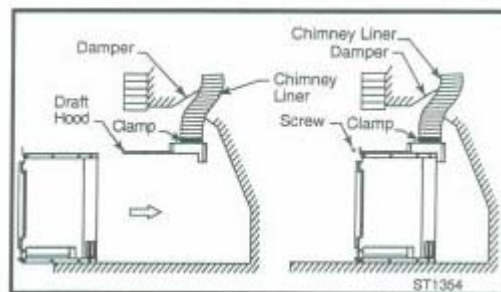

Fig. 11 Remove flue collar plate and attach to flue collar.

- **Draught Relief Opening**

This insert is equipped with a draught-relief opening which receives its dilution air supply through the opening at the back of the insert. These openings must not be obstructed or entered in any way. (Ref Fig.12)

- **Test Chimney Draw**

1. A “Chimney Draw” test must be conducted before the installation is complete.
2. Close all doors and windows in the home and start exhaust fans in the kitchen and bathroom/s.
3. Light unit and operate for 5 minutes.
4. Hold an ignited match or candle in front of the unit. Refer to drawing number Fig.12 for the location of the draught hood opening.
5. Check to make sure the smoke from the match or candle is drawn into the fireplace. If it is not, turn unit off and check for causes creating the lack of adequate draught.

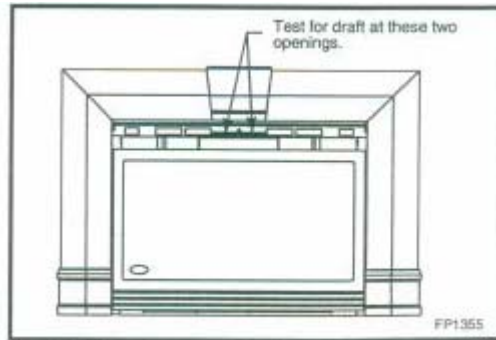

Fig. 12 Hold an ignited match in front of fireplace.

- **Blocked Flue Shut Off System**

These inserts are equipped with a blocked flue shut off switch. This switch is factory fitted, wired and tested. Check to make sure the switch and wires are in the correct position. The shut off switch is heat activated and wired in series with the pilot system. (Ref Fig. 13)

Warning: Operation of this fireplace when not connected to a properly installed and maintained flue or tampering with the blocked flue shut off system can result in carbon monoxide (CO) poisoning and possible death.

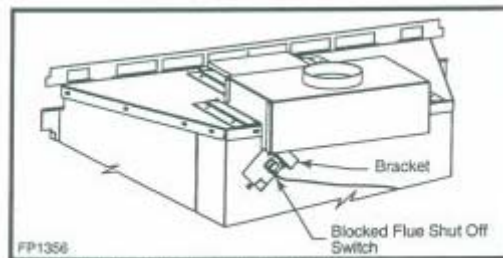

Fig. 13 Blocked flue shut off switch location.

- **Blocked Flue Shut Off Switch Access**

The shut off switch system of these inserts is designed to be accessed from either inside the combustion firebox chamber or outside at the back of the inserts fireplace.

Access to the shut off switch from the outside of the insert

1. Turn off the unit and let it cool down if it has been operating.
2. Shut off the gas and the power supply to the fireplace.
3. Disconnect the gas line and the draught hood of the fireplace.
4. Slide the fireplace out.

Access to the shut off switch directly from inside the combustion firebox chamber.

1. Turn off the unit and let it cool down if it has been operating.
2. Remove the log set and remove the ceramic refractory if installed.
3. Remove firebox baffle (Ref Fig. 14)

4. Remove the shut off switch cover fastened with four (4) screws located at the upper right corner of the firebox.
5. Now you can access the shut off switch assembly through the rectangular opening. Remove the screw that secures the switch assembly. Holding the bracket switch carefully, pull out the entire switch assembly.

NOTE: The shut off switch cover was attached with the gasket cover. Before re-installing the gasket cover, inspect and make sure the gasket is not damaged. If the gasket is damaged, install a new gasket.

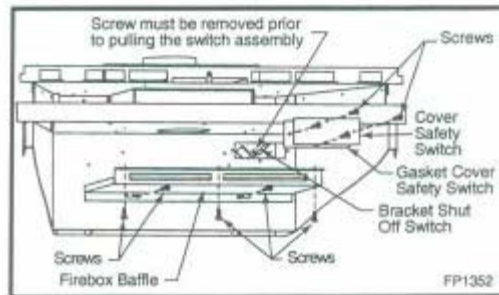

Fig. 14 Access to the blocked flue shut off switch from inside combustion chamber.

- **Ceramic Refractory Installation (Optional)**

1. Remove front glass.
2. Remove logs from heater.
3. Remove refractory from package.

Warning: Refractories are fragile and must be handled with care. Where at all possible two hands should be used when handling.

4. Take centre refractory and tilt so that bottom edge seats onto the rear log bracket at the back wall of the fireplace. (Ref Fig. 15)
5. Press centre refractory to back side of fireplace and hold in place.
6. Take left or right hand refractory and align it so leading edge faces outward. (Place refractory in fireplace side and slide it back to support the centre refractory.)
7. Repeat step 6 for remaining side refractory.
8. Fasten bracket supports against refractory top to hold side in place.

Warning: When side refractory is installed correctly, the centre refractory will be supported by the side refractory.

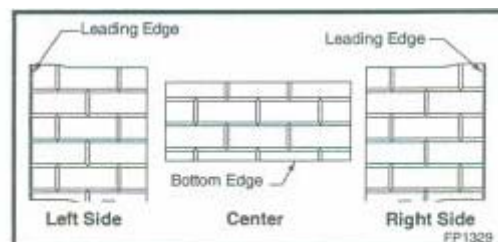

Fig. 15 Ceramic refractory. 10005360

Part 3: Operating Instructions

NOTE: Carbon deposits may be present on the glass and logs. This is normal and must be cleaned when the appliance is serviced or the glass door is cleaned. Please refer to the General Glass Information section on page 15.

- **General Glass Information**

Warning: Only ceramic glass approved by Raypak Australia may be used for replacement on this unit.

1. The use of substitute glass will void all product warranties.
2. Care must be taken to avoid breakage of glass.
3. Under no circumstances should this appliance be operated without glass properly installed or with any cracked or broken glass. Replacement of any glass assembly as supplied by the manufacturer should be carried out by a suitably licensed and qualified service person.

- **Louvre Removal**

To remove louvre, lift louvre up and then pull out (Ref Fig. 16)

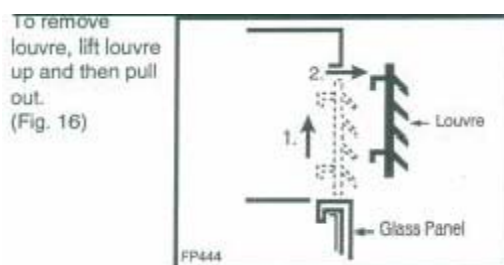

- **Glass Cleaning**

It will be necessary to clean the glass periodically. During start up condensation, which is normal, forms on the inside of the glass and causes lint, dust and other airborne particles to cling to the glass surface. Initial paint curing may deposit a slight film on the glass. It is therefore recommended that the glass be cleaned two or three times with a non-ammonia household cleaner and warm water. After this the glass should be cleaned two or three times during each heating season or as required.

Warning: Clean glass after first two weeks of operation.

- **Glass Frame Removal**

1. Remove two (2) screws at the bottom of the frame. (Ref Fig. 17)
2. Lift up and unhook glass frame at the top.

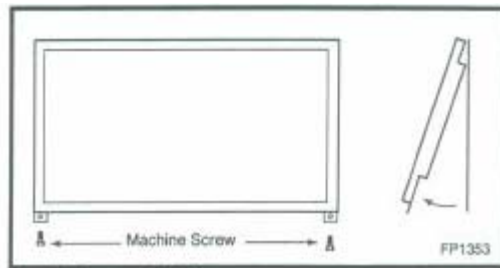

Fig. 17 Remove glass frame.

- **Log Installation and Burner Lava Rock**

1. Remove glass frame. (See “Glass Removal” section)
2. Remove logs from packaging.
3. Place logs according to the following instructions.
 - a) Place the rear centre log (KR24). Use the log’s bottom holes to locate it onto the two (2) pin studs of the rear log bracket on the centre.
 - b) Place rear left log (KR22). Use the log’s bottom holes to locate it onto the two (2) pin studs of the rear log bracket on the left.
 - c) Place rear right log (KR23). Use the log’s bottom holes to locate it onto the two (2) pin studs of the rear log bracket on the right.
 - d) Place the front left log (KR25). Position the log notch against the second grate from the left and the other edge of the log on top of the rear right log notch. Ensure the log is secure in place.
 - e) Place the front right log (KR26). Position the log notch against the third grate from the right and the other edge of the log on top of the rear right log notch. Ensure log is secure in place
 - f) Place the burner lava rock on the front area of the burner housing. (Refer Fig. 19)

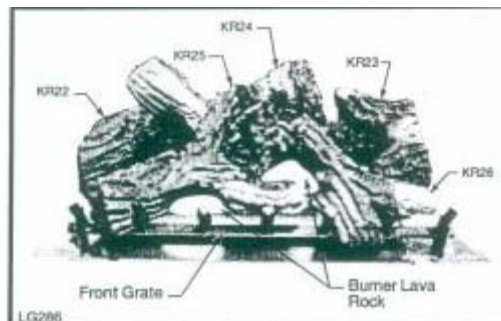

Fig. 19 LHEC30 log and lava rock placement.

- **Large Lava Rock Placement**

The large lava rock provided with this fireplace should be placed on the firebox base on either side of the burner assembly.

Warning: Under no circumstances should these lava rocks be placed on top of the burner assembly.

- **Flame Characteristics**

It is important to periodically perform a visual check of the pilot and the burner flames. Compare then to the drawings Figure 20, 21 and 22. If any of the flame appear abnormal turn the appliance off and place a service call.

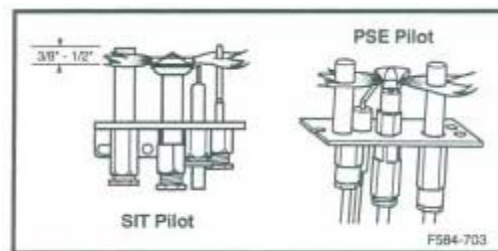

Fig. 22 Correct pilot flame appearance.



Fig. 24 Correct burner flame appearance for LHEC30.

- **First Firing**

Upon completion of the gas line connection, a small amount of air will be in the fitting line. When first lighting the pilot light it will take a few minute to purge the air out of the system. Once the purging is complete, the pilot and burner will light and will operate as indicated in the instruction manual. Subsequent lighting of the appliance will not require such purging.

When lit for the first time, the appliance will emit a slight order for a short period of time. This is due to the paints and lubricants used in the manufacturing process. After each lighting, vapour may condense and fog the glass, this moisture disappears within a few minutes of operation.

Lighting And Operating Instructions

FOR YOUR SAFETY READ BEFORE LIGHTING

WARNING: If you do not follow these instructions exactly, a fire or explosion may result causing property damage, personal injury or loss of life.

- A. This heater has a pilot which must be lit manually. When lighting the pilot follow these instructions exactly.
- B. BEFORE LIGHTING smell all around the heater area for gas. Be sure to smell next to the floor because some gas is heavier than air and will settle on the floor.

WHAT TO DO IF YOU SMELL GAS

- Do not try to light any fireplace
- Do not touch any electric switch
- Do not use any phone in your building
- Immediately call your gas supplier from a neighbor's phone. Follow the gas supplier's

Instructions.

- If you cannot reach your gas supplier, call the Fire Department
- C. Use only your hand to push in or turn the gas control knob. Never use tools. If the knob will not push in or turn by hand, do not try to repair it, call a qualified service technician. Applying force or any attempted repair may result in a fire or explosion.
- D. Do not use this fireplace if any part has been under water. Immediately call a qualified service technician to inspect the heater and to replace any part of the control system and any gas control which has been under water.

Lighting Instructions

1. **STOP!** Read the safety information above.
2. Turn off all electrical power to the fireplace.
3. For MN/MP/TN/TP appliances ONLY, go on to Step 4. For RN/RP appliances turn the On/Off switch to "OFF" position or set thermostat to lowest level.
4. Open control access panel.
5. Push in gas control knob slightly and turn clockwise to "OFF".

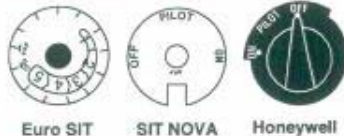

6. Wait five (5) minutes to clear out any gas. Then smell for gas, including near the floor. If you smell gas, **STOP!** Follow "B" in the safety information above. If you do not smell gas, go to the next step.
7. Remove glass door before lighting pilot. (See Glass Frame Removal section).
8. Visibly locate pilot by the main burner.
9. Turn knob on gas control counterclockwise to "PILOT".

10. Push the control knob all the way in and hold. Immediately light the pilot by repeatedly depressing the piezo spark ignitor until a flame appears. Continue to hold the control knob in for about one (1) minute after the pilot is lit. Release knob and it will pop back up. Pilot should remain lit. If it goes out, repeat steps 5 through 8.



- If knob does not pop up when released, stop and immediately call your service technician or gas supplier.
 - If after several tries, the pilot will not stay lit, turn the gas control knob to " " and call your service technician or gas supplier.
11. Replace glass door.
 12. Turn gas control knob to "ON" position.
 13. For RN/RP appliances turn the On/Off switch to "ON" position or set thermostat to desired setting.
 14. Turn on all electrical power to the fireplace.

To Turn Off Gas To Heater

1. Turn the On/Off switch to "OFF" position or set the thermostat to lowest setting.
2. Turn off all electric power to the fireplace if service is to be performed.
3. Open control access panel.
4. Push in gas control knob slightly and turn clockwise to "OFF". Do not force.
5. Close control access panel.

Troubleshooting the Gas Control System

Honeywell Millivolt Valve

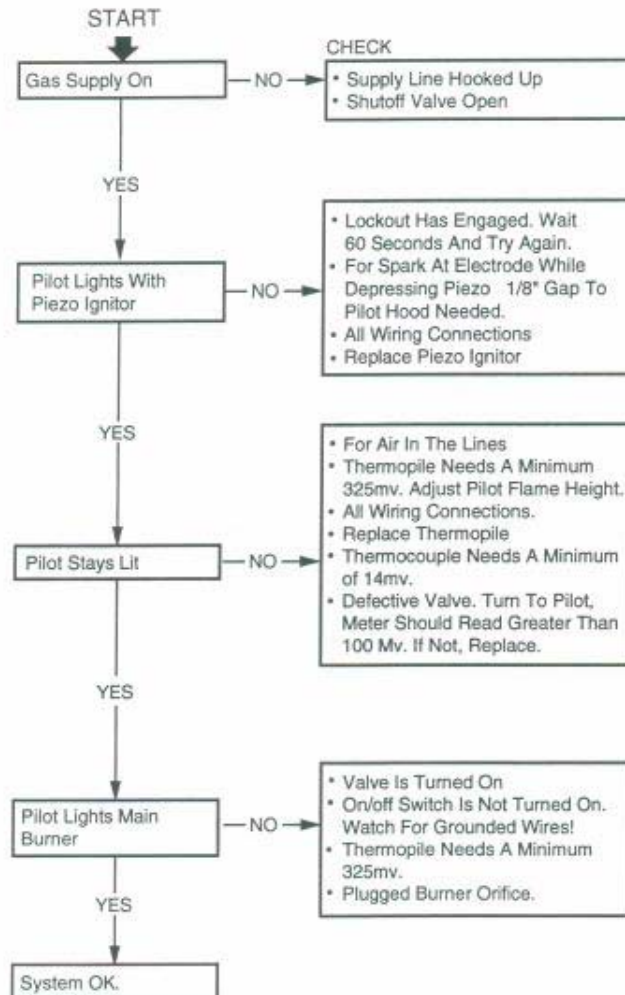

Instructions for RF Comfort Control Valve

The Comfort Control Valve allows remote control of temperature, fan and flame appearance.

NOTE: The antenna should hang in free air away from grounded metal.

Operation

1. If the manual switch is in remote position, switch it to LOCAL. (Fig. 25)
2. Turn the pilotstat knob counterclockwise from OFF to the PILOT position, push the knob down, and hold in position. The pilot valve opens and allows gas to flow to the pilot burner.
3. Push plunger on the piezo until the pilot burner is lit. When the pilot burner is lit, the LED on the control will come on after approximately 40 seconds and will be continuously red. When the light turns off which will be approximately 10 seconds after it has been continuously red, the receiver/valve is fully powered.

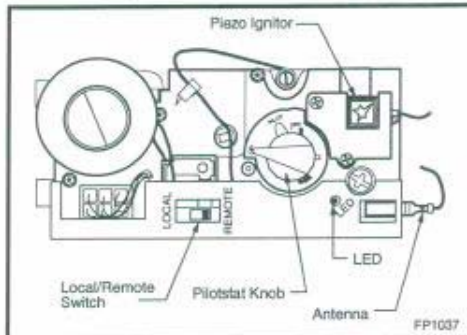

Fig. 25 Comfort control valve.

4. Release the knob. The shaft will move upward. The pilot burner should now stay burning. If the pilot burner goes out, repeat step 2.
5. Turn the knob counterclockwise to the ON position. If the manual switch is in the LOCAL position, the main burner will turn on immediately.
6. ON the initial use of a transmitter, a recognition operation is required between the receiver/valve and transmitter. Change the switch from LOCAL to REMOTE. Press the fan or flame button on the transmitter within 30 seconds. The LED will blink indicating the transmitter will now work with the receiver/valve. If the switch continues in the REMOTE position, the transmitter will now control the main valve, flame modulation level and fan control.

7. If the manual switch is in the LOCAL position, the valve will be at the highest fixed pressure setting. The transmitter will control the fan only.

Shut Off Procedure

If the manual switch is in the REMOTE position, the transmitter can shut off the main burner and fan. However, the control is still on and a command from the transmitter can turn on the main burner or fan.

To shut off the system, turn the pilotstat knob clockwise to the OFF position. This action closes the main gas and safety valves. The transmitter cannot turn on the main burner or fan.

Transmitter Operation

Off Mode

In the OFF mode, the fireplace flame and fan are off, the display will show OFF and displays the room temperature. If the receiver is in REMOTE mode, the fireplace will shut off.

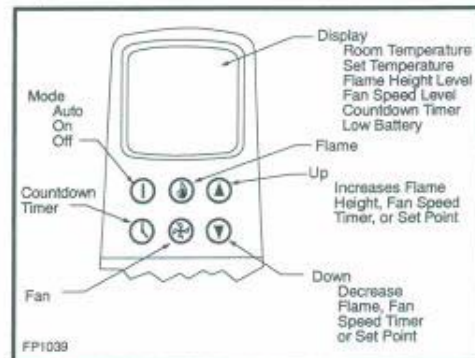

Fig. 26 Transmitter diagram.

On (Manual) Mode

In the ON mode, the room temperature, flame and fan levels will be shown. MANUAL will appear next to both the flame and fan icons.

When the control is in the ON mode, the flame and fan levels, and delay timer are changed with the up and down buttons. To change the flame level, press the flame button followed by an arrow key. To change the fan level, press the fan key followed by an arrow key. Pushing the arrow key once will change the level by one unit.

Delay Timer Mode

The shut off delay timer has a maximum of 2 hours and a minimum of zero minutes. To change the timer level, press the time key followed by an arrow key. Pushing the key once will change the timer by 10 minutes.

Auto Mode

In the AUTO mode, the room temperature, set temperature, flame and fan levels will be shown. AUTO will appear next to both the flame and fan icons.

When the control is in the AUTO mode, the main burner will turn on/off or modulate based on the heat needed to maintain the set temperature. The flame level will change automatically to optimize the heat output needed to maintain the set temperature. To change the set temperature, press the up or down key. Pushing a key once will change the temperature by one degree.

In the AUTO mode, the fan speed will increase with increasing flame height or decrease with decreasing flame height. "AUTO" is displayed next to the flame and fan icons.

Fan Override During Auto Mode

If a lower or higher fan speed is desired when operating in the AUTO mode, the fan speed can be overridden by pushing the fan button followed by the up or down key. Pushing a key once will change the fan level by one unit. In this mode "AUTO" is displayed next to the flame icon and "MANUAL" is displayed next to the fan icon.

Change Between F/C Temperature Units

Push the up and down arrow keys simultaneously for at least 3 seconds to toggle between Fahrenheit and Celsius units.

Disable Thermostat Function

To disable the thermostat function in the AUTO mode, push the time and down keys simultaneously for at least 3 seconds.

To Change Batteries

1. Remove cover on the backside of the transmitter. Install 3 AAA batteries as shown and reattach cover.
2. Once steps 1-3 in OPERATION are completed, receiver/valve and transmitter are now ready. Press any button on transmitter for recognition process to occur between the receiver/valve and transmitter.
3. Use functions as described in TRANSMITTER section.

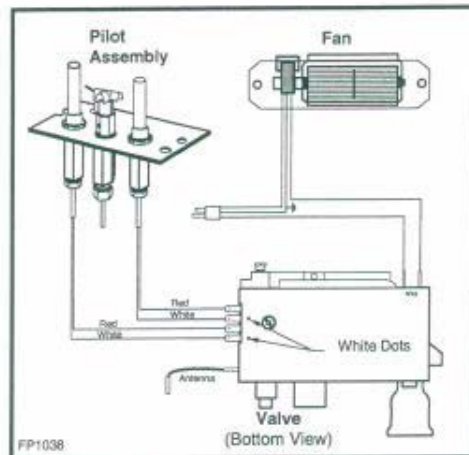

Fig. 27 Comfort Valve wiring diagram.

Troubleshooting

1. Locate LED light on valve.
2. LED will blink after every valid command received by the transmitter; this is not an error.
3. Failure codes may occur anytime after pilot burner is lit.
4. Sequence is failure code followed by light not blinking for 30 seconds.
5. In the event of multiple failure codes, next failure code follows previous failure code by approximately 3 seconds.

If an Error Code 3 is observed while performing the testing, complete the following:

1. Make sure the spade connectors are pushed all the way on. If the Error Code 3 is still showing, then go to the next step.
2. Switch the front two thermopile leads with the back two. Be sure the white lead is connected to the spade with the white dot next to it. If the Error Code 3 is still showing, replace the thermopiles.

If an Error Code 8 is observed while performing the testing, complete the following:

1. Confirm the valve is not in REMOTE mode.
 - If the valve is producing Error Code 8 and in REMOTE mode, the valve is defective and should be replaced.
 - If the valve is in LOCAL mode and producing Error Code 8, then go to the next step.

- Slide the Remote/Local switch to REMOTE and teach the valve a transmitter (refer to Item 6, page 1). The Error Code will clear itself after approximately 1½ minutes and return to normal operation.

LED Count	Service Action
8	Replace valve
7	Confirm stepper motor connection exists
5	Confirm fan connection exists and works
4	Confirm gas type; jumper in place
3	Replace thermopiles
2	Turn fan ON

NOTE: Some keys are not active.

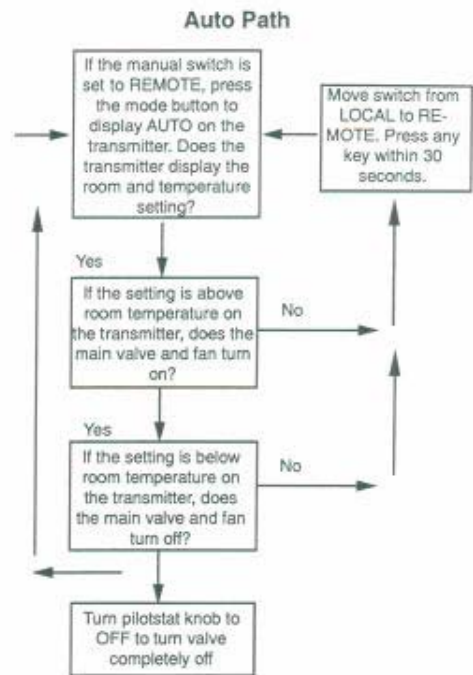

Comfort Valve system control sequence of operation with transmitter

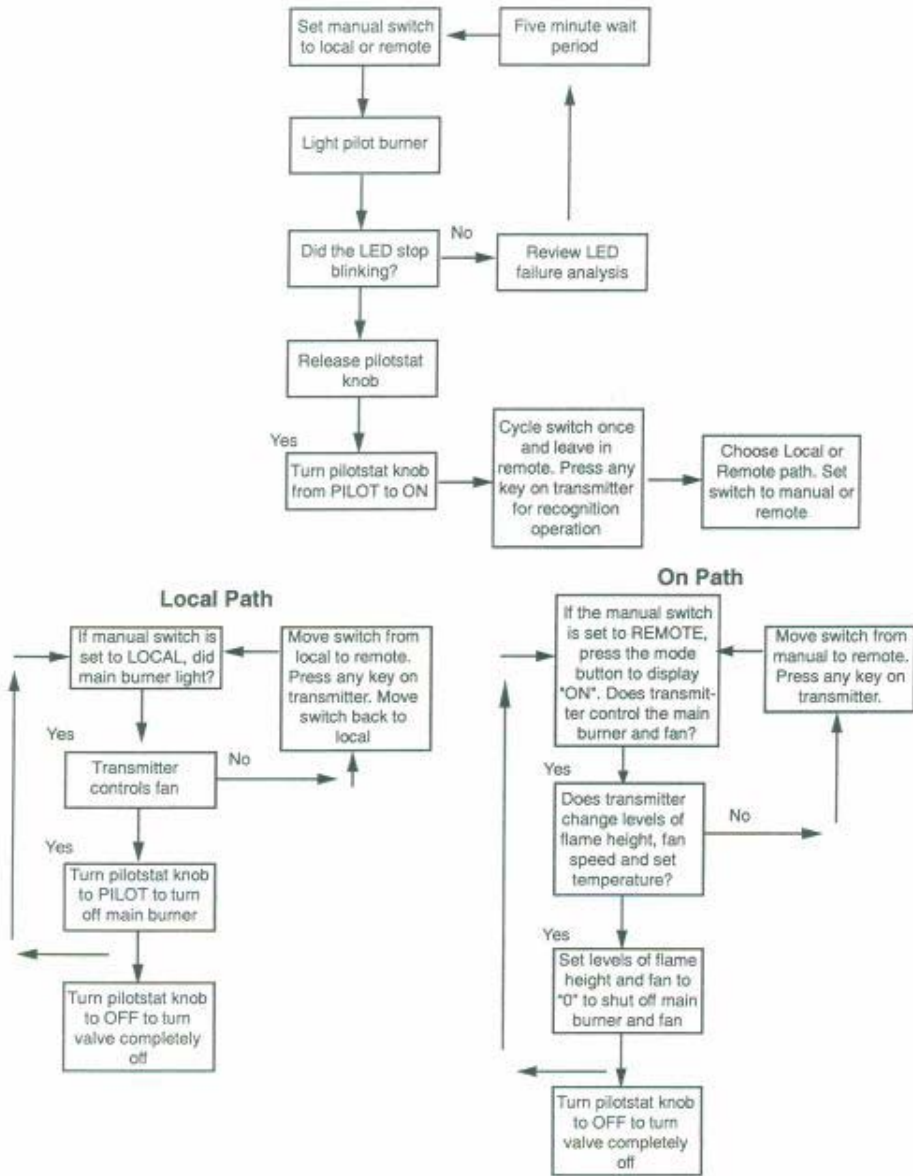

Maintenance

Burner and Burner Compartment

It is important to keep the burner and the burner compartment clean. At least once per year the logs and lava rock/ember material should be removed and the burner compartment vacuumed and wiped out. Remove and replace the logs as per the instructions in this manual.



Always handle the logs with care as they are fragile and may also be hot if the fireplace has been in use.

Fan Assembly

The fan unit requires periodic cleaning. At least once per month in the operating season, open the lower louvre panels and wipe or vacuum the area around the fan to remove any build up of dust or lint.

Cleaning the Standing Pilot Control System

The burner and control system consists of:

- main burner
- pilot burner
- gas orifice
- thermopile
- combination millivolt gas valve

Most of these components may require only an occasional checkup and cleaning and some may require adjustment. If repair is necessary, it should be performed by a qualified technician.

In order to properly clean the burner and pilot assembly, turn off the gas to the unit, remove the window frame panel and logs exposing the burner and pilot assembly. Clean all foreign materials from the top of the burner. Check to make sure that burner parts are clean.

Visually inspect pilot. Brush or blow away any dust or lint accumulation. If pilot orifice is plugged, disassembly may be required to remove any foreign material from the orifice or tubing.

To obtain proper operation, it is imperative that the pilot and burner's flame characteristics are steady, not lifting or floating.

Typically, the top 1/8" of the thermopile should be engulfed in the pilot flame. (Page 12, Fig. 22)

Trim Cleaning

Clean the trim with a soft clean cloth, slightly dampened with lemon oil and buff with a soft dry cloth. Do not use brass polish or household cleaners as these products will damage the trim. Lemon oil can be obtained at supermarkets or hardware stores.

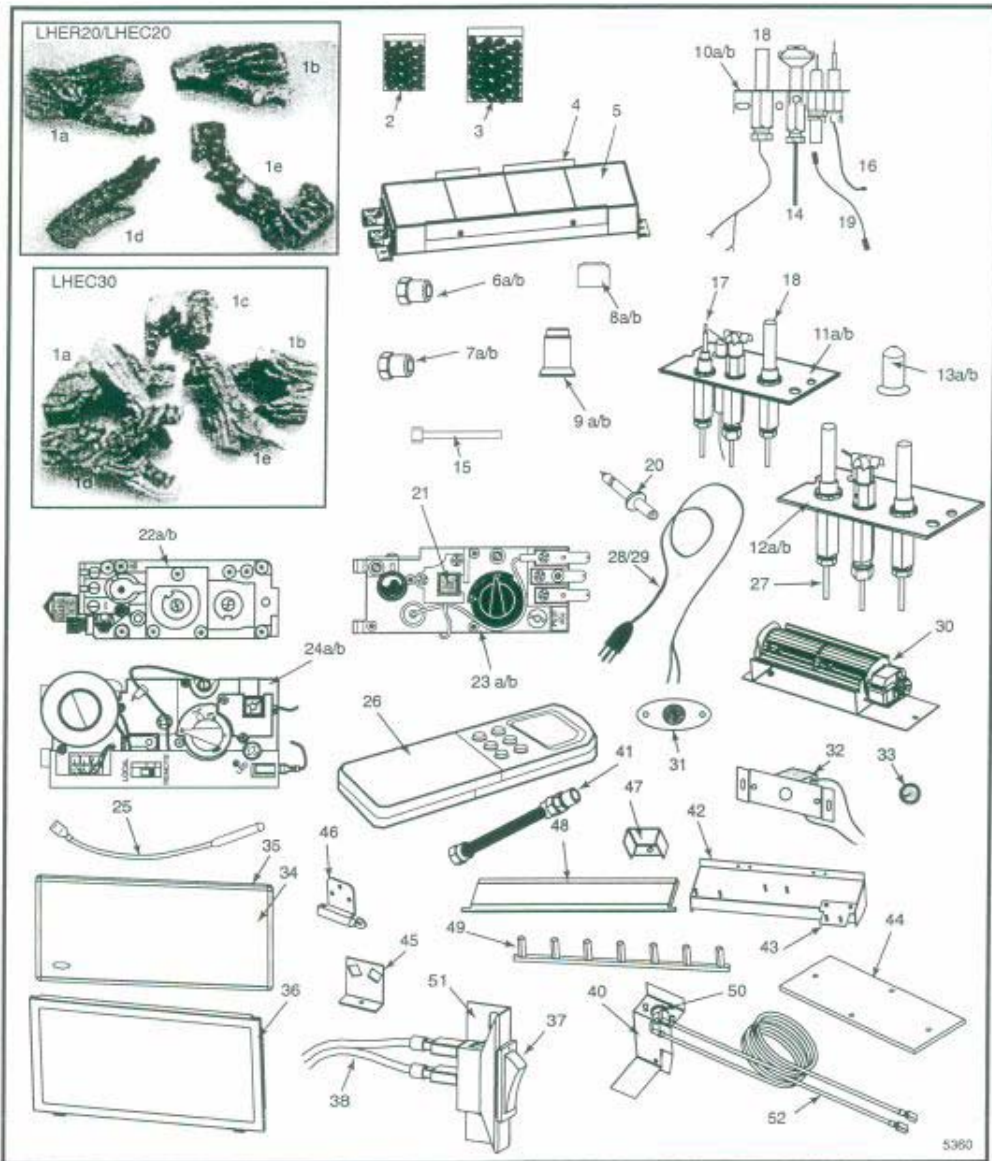

Vermont Castings, Majestic Products reserves the right to make changes in design, materials, specifications, prices and discontinue colors and products at any time, without notice.

LHE Series

LHE Series (continued)

Ref.	Description	LHER20	LHEC20	LHEC30
1.	Log Set Complete	10005332	10005332	10004866
1a.	Log Rear Left	JR7	JR7	KR22
1b.	Log Rear Right	JR8	JR8	KR23
1c.	Log Rear Center	-	-	KR24
1d.	Log Front Left	JR9	JR9	KR25
1e.	Log Front Right	JR10	JR10	KR26
2.	Lava Rock Burner Package	57897	57897	57897
3.	Lava Rock Package	-	-	10001454
4.	Burner Housing Assembly with Tiles	10005294	10005294	10004972
5.	Ceramic Tile (Single)	57803	57803	57803
6a.	Orifice Front Burner (Nat.)	See Rating Plate for Orifice Size		
6b.	Orifice Front Burner (Prop)	See Rating Plate for Orifice Size		
7a.	Orifice Rear Burner (Nat.)	See Rating Plate for Orifice Size		
7b.	Orifice Rear Burner (Prop.)	See Rating Plate for Orifice Size		
8a.	Orifice Pilot SIT Top Convertible	10002268	10002268	10002268
8b.	Orifice Pilot SIT Top Convertible	10002269	10002269	10002269
9a.	Orifice Pilot PSE (Nat.)	10001822	10001822	10001822
9b.	Orifice Pilot PSE (Prop.)	10001823	10001823	10001823
10a.	Pilot Assembly SIT Top Convertible (Nat.)	10002389	10002389	10002389
10b.	Pilot Assembly SIT Top Convertible (Prop.)	10002390	10002390	10002390
11a.	Pilot Assembly PSE (Nat.)	10001741	10001741	10001741
11b.	Pilot Assembly PSE (Prop.)	10001742	10001742	10001742
12a.	Pilot Assembly RFN (Nat.)	-	20002266	20002266
12b.	Pilot Assembly RFP (Prop.)	-	20002268	20002268
13a.	Pilot Orifice RFN (Nat.)	-	20000908	20000908
13b.	Pilot Orifice RFP (Prop.)	-	20000907	20000907
14.	Pilot Tubing w/Fittings	10001296	10001296	10001296
15.	Manifold Tubing w/Fittings	57318	57318	57318
16.	Thermocouple SIT	53373	53373	53373
17.	Thermocouple PSE	10001825	10001825	10001825
18.	Thermopile	51827	51827	51827
19.	Electrode Ignitor w/Cable SIT	10001297	10001297	10001297
20.	Ignitor Piezo SIT	52464	52464	52464
21.	Ignitor Piezo Honeywell	20000062	20000062	20000062
22a.	Valve SIT 820 RN	52677	52677	52677
22b.	Valve SIT 820 RP	52678	52678	52678
23a.	Valve Honeywell RN	10001782	10001782	10001782
23b.	Valve Honeywell RP	10001759	10001759	10001759
24a.	Valve Honeywell RFN	-	20003719	20003719
24b.	Valve Honeywell RFP	-	20003720	20003720
25.	Antennae (for RFN or RFP Units)	-	20003561	20003561
26.	Transmitter (for RFN or RFP Units)	-	20002047	20002047
27.	Thermopile (for RFN or RFP Units)	-	20002400	20002400
28.	Cord Set (for RFN or RFP Units)	-	20002541	20002541
29.	Cord Set (for RN or RP Units)	51865	51865	51865
30.	Fan with Bracket	54103	54103	54103
31.	Fan Temperature Sensor (for RN or RP Units)	51704	51704	51704
32.	Speed Control Switch (for RN or RP Units)	51738	51738	51738
33.	Speed Control Knob (for RN or RP Units)	51882	51882	51882

LHE Series (continued)

Ref.	Description	LHER20	LHEC20	LHEC30
34.	Glass with Gasket	10005526	10005525	10004989
35.	Gaskeet Glass	57317	57317	57317
36.	Frame Window	10005295	10005067	10004873
37.	Remote Switch (for RN or RP Units)	53606	53606	53606
38.	Remote Wire Harness w/Terminals (for RN or RP Units)	10002582	10002582	10002582
39.	Ceramic Fiber Brick FP (Optional)	JT1TR0	JT1TC0	KT1TC0
40.	Bracket Sensor	10004980	10004980	10004980
41.	Flexible Connector (6")	10005098	10005098	10005098
42.	Bracket Rear Log Assembly	10005370	10005369	10005489
43.	Bracket Log Support Assembly	-	-	10004885
44.	Gasket Cover Sensor Access	10005007	10005007	10005007
45.	Bracket Support Grate	-	-	10003479
46.	Hinge 2 Springs	52356	52356	52356
47.	Shield Heat Pilot	10000248	10000248	10000248
48.	Sensor Safety Switch Assy	10005074	10005074	10005074
49.	Grate Assembly Flat Black	10004967	10004967	10004967
50.	Sensor Spill Switch	51866	51866	51866
51.	Bracket ON/OFF Switch	10005035	10005035	10005035
52.	Wiring Safety Switch	10005073	10005073	10005073

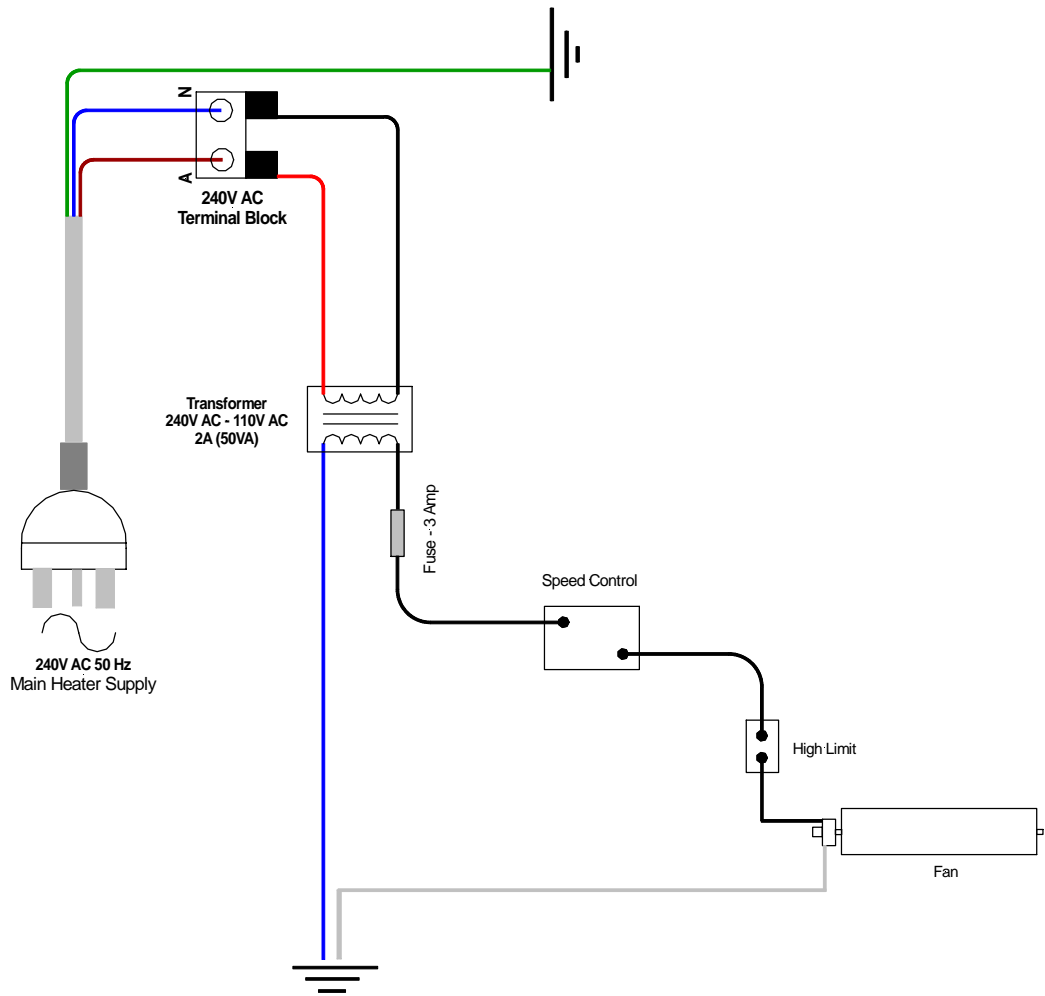

LHEC30RFN/P WIRING DIAGRAM

Part 4: Warranty

**RAYPAK VERMONT LHEC30RFNAU & LHEC30RFPAU
GAS LOG FIREPLACE INSERT WARRANTY
- AUSTRALIA ONLY -**

Rheem Australia * will:

- a) Repair or, if necessary replace any Raypak LHEC30RF Gas Log Fireplace Insert, or
- b) Replace any component (or, if necessary, arrange the installation of a Raypak Gas Log Fireplace Insert, which falls within the Warranty Periods specified below, in accordance with and subject table, conditions and exclusions.

Installation	Models	Period	Warranty
From date of installation			
Gas Log Fire Place Inserts	LHEC30RFNAU & LHEC30RFPAU	Year 1	Labour
Gas Log Fire Place Inserts	LHEC30RFNAU & LHEC30RFPAU	Years 2 Parts	Fan and other components
Gas Log Fire Place Inserts	LHEC30RFNAU & LHEC30RFPAU	Years 10 Parts	This warranty covers the appliance heat exchanger for 10 years pro-rata with a 1 year labour warranty.

Notes:

- * Rheem Australia Pty Ltd provides warranty service and spare parts on behalf of Raypak Australia Pty. Ltd.
- ** Refer to item 5 of warranty conditions.

Rheem reserves the right to transfer fully functional components from the defective gas log fire to the replacement gas log fire if required.

In addition to this warranty, the Trade Practices Act 1974 and similar laws in each state and territory provide the owner under certain circumstances with certain minimum statutory rights in relation to your Raypak gas log fire. This warranty must be read subject to that legislation and nothing in this warranty has the effect of excluding, restricting or modifying those rights.

Rheem Australia Pty Ltd A.B.N 21 098 823 511 Raypak Australia Pty Ltd A.B.N 65 078 743 414	FOR SERVICE TELEPHONE 131 031 AUSTRALIA or refer to your local yellow pages
---	--

RAYPAK VERMONT LHEC30RFNAU AND LHEC30RFPAU WARRANTY - AUSTRALIA ONLY -

WARRANTY CONDITIONS

1. This warranty is applicable only to the LHEC30RFNAU and the LHEC30RFPAU gas log fires manufactured from August 2005
2. The gas log fire must be installed in accordance with the Raypak installation instructions, supplied with the appliance and in accordance with all relevant statutory and local requirements of the State in which the appliance is installed.
3. This gas log fire must be correctly commissioned by a licensed and authorised person and the installation certified by the relevant Gas Authority of the State in which the appliance is installed.
4. Where a failed component or gas log fire is replaced under warranty, the balance of the original warranty period will remain effective. The replaced part of gas log fire does not carry a new warranty.
5. Where the gas log fire is installed outside the boundaries of the metropolitan area as defined by Rheem or further than 25 km from a regional Rheem branch office, or an accredited service agent, the cost of transport, insurance and travelling costs between the nearest Rheem accredited Service Agent's premises and the installed site shall be owner's responsibility.
6. The warranty only applies to the gas log fire and original or genuine (company) component replacement parts and therefore does not cover any plumbing or electrical parts supplied by the installer and not an integral part of the appliance.

Distributed By: RAYPAK AUSTRALIA PTY. LTD.
39 Koornang Rd
Scoresby Vic 3179

Ph: 03 9757 3333
Fax: 03 9757 3350

For Service and Spare Parts Call: 131 031